

INDUSTRIJSKO-OBRTNIČKA ŠKOLA SISAK
Marijana Cvetkovića 2
44010 Sisak
ured@ss-industrijsko-obrtnicka-sk.skole.hr
044/537 218

UČENIČKA ZADRUGA ZIOŠI



Naziv učeničke zadruge:

Naziv odgojno-obrazovne ustanove:

Adresa odgojno-obrazovne ustanove:

Telefon:

Faks:

e-mail:

Godina osnutka:

Predsjednica učeničke zadruge:

Zamjenica predsjednice:

Tajnica zadruge:

Broj sekcija:

UZ ZIOŠI

Industrijsko – obrtnička škola Sisak

Marijana Cvetkovića 2, 44010 Sisak

044 / 537- 218

044 / 538 - 962

ured@ss-industrijsko-obrtnicka-sk.skole.hr

4. svibnja 2023.

Marija Kosić, mag. ing.

Marina Hren, dipl. pedagog

Mirjana Bistrički

8 / 6

Ravnatelj:
dr.sc. Ivan Vrbik

Voditelji sekcija zadruga:

Marko Čulibrk i Krešo Vukelić, stručni učitelji

Aleksandar Branković, ing.

Mirela Petrović, prof. i Ana Bauitti, dipl. knjižničar

Marija Kosić, mag. ing.

Zdenko Golem, prof. i Ivanka Papić

Oriana Zgombić, dipl. ing.

Predviđen broj sati rada sekcija godišnje: 35 sati

Broj učenika zadrugara:

cca 30

Uzrast zadrugara:

od prvog do trećeg razreda srednje škole

Mjesto izvođenja aktivnosti:

škola i lokalna zajednica

Broj	Naziv sekcije	Voditelj sekcije
1.	Praktičari - sekcija praktične nastave 1. godine	Marko Čulibrk i Krešo Vukelić, stručni učitelji
2.	Špena - sekcija CNC operatera	Aleksandar Branković, ing.
3.	Kiss - kulturno informativna sekcija Sisak	Mirela Petrović, prof. i Ana Baiutti, dipl. knjiž.
4.	Puls - sekcija praktične umjetnosti i logistike	Marija Kosić, mag. ing.
5.	Zelena oaza	Zdenko Golem, prof. i Ivanka Papić
6.	Eko svijet	Oriana Zgombić, dipl. ing.

travanj 2023.

Početak rada naše Učeničke
zadruga ZIOŠI obilježili su
Praktičari izradom ukrasnih stalaka
za cvijeće.

Noj je krasio i Sisački sajam
cvijeća.



5. 05. 2023. 12:48

4. 05. 2023. 14:40

12. travnja 2023.

Održan je sastanak Podružnice HSUZ-a Sisačko-moslavačke županije u OŠ Viktorovac i kreativno-tehnička radionica - *Drvene kutije ukrašene dekupaž tehnikom*, Senka Štetić, UZ Lovrakovci, OŠ Mate Lovraka Kutina.



12. svibnja 2023.

Učenička zadruga ZIOŠI sudjelovala je u obilježavanju
Majčina dana prodajnom izložbom u holu škole.



Sekcije Praktičari & Puls

Unikatna roda nastala u sklopu praktične nastave vrijednih učenika i nastavnika.



20. svibnja 2023.

UZ ZIOŠI sudjelovala je na 17. Sajmu udruga i obrta u Sisku na Svjetski dan pčela što je simbolički prikazano radom Zadruga.



12. lipnja – 23. lipnja 2023.

Svojim radova UZ ZIOŠI sudjelovala je na izložbi povodom 430 godina od Bitke kod Siska.



21. lipnja – 22. srpnja 2023.

Prodajnom izložbom Zadruga je sudjelovala na XXVII.
Državnoj konjogojskoj izložbi u Sunji. Radovi su bili
izloženi za prodaju i u holu škole.



15. rujna 2023.

Humanitarnoj aktivnosti Mliječna staza
2023. pridružila se Zadruga.



22. listopada 2023.

Na 2. Regionalnom sajmu kulture razvojne suradnje u Petrinji UZ se predstavila prodajnom izložbom.



10. studenoga 2023.

Ekološke aktivnosti Zadruga je započela prikupljanjem starih baterija u suradnji s tvrtkom FRIŠ d.o.o.

Aktivnost još traje.



11. studenoga 2023.

Održan je sastanak Podružnice HSUZ-a Sisačko-moslavačke županije u OŠ Sela s ciljem međuzupanijske suradnje učeničkih zadruga Sisačko-moslavačke i Karlovačke županije. Tom prigodom održane su radionice:

1. Slikanje uz čaj - Stefanija Kranjčec, OŠ Turanj, Karlovac, UZ Štokrlica
2. Narukvice prijateljstva - Lorena Sopčić, OŠ Žakanje, Žakanje, UZ Brezik
3. Makrame lutkice- Katarina Dobrenić, OŠ "Braća Bobetko", Sisak, UZ Leptirići
4. Izrada privjesaka od perlica Maja Ostojić, OŠ Ivana Gorana Kovačića, Gora, UZ Goranka



15./ 16. studenoga 2023.

Održan je stručni skup za voditelje učeničkih zadruga i sekcija u učeničkim zadrugama u Termama Tuhelj. Tema skupa bila je Razvoj poduzetničke ideje od koncepta do realizacije s dnevnim redom:

- Poduzetničke vještine u svakodnevnom životu, Ružica Kandić, prof., univ. spec. oec., Agencija za odgoj i obrazovanje, Podružnica Split
- Je li proizvod dovoljan?, Tihomir Antunović, dipl. oec., Medora hoteli i ljetovališta d. d., Zagreb
- Oznake kvalitete za poticanje vrijednosti proizvoda Učeničkih zadruga, Sanja Baković, mag. oec., Hrvatska gospodarska komora, Split
- Poticanje darovitosti za poduzetništvo kroz likovnu kulturu, Mateja Rusak, mag. art., Srednja strukovna škola
- Varaždin, Iva Vukotić, mag. oec., Gospodarska škola Varaždin
- Sritnica brand – primjer traženog proizvoda UZ na tržištu, Zdenka Ljubičić, prof., OŠ Josipa Jovića, Aržano



studeni 2023.

Zadruga je sudjelovala u razvoju kalupa za lijevanje papirne pulpe te u izradi blagdanskih ukrasa.

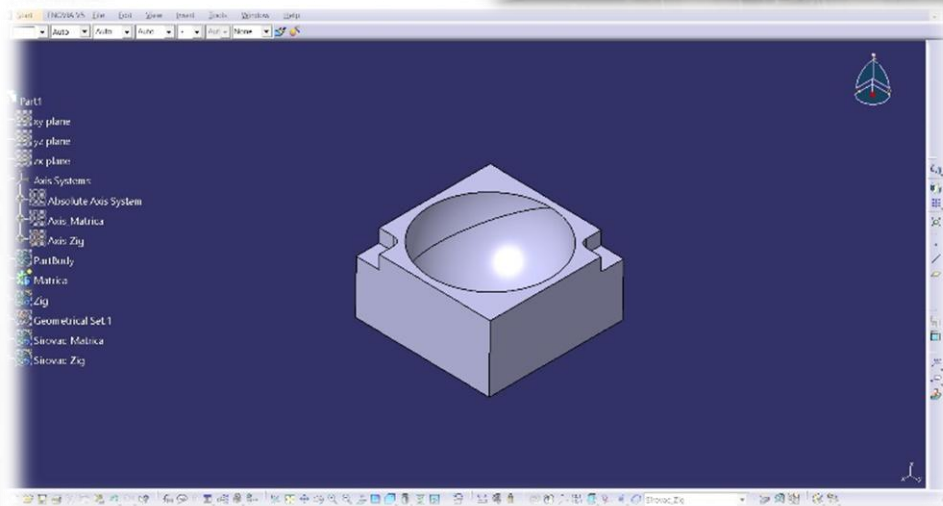
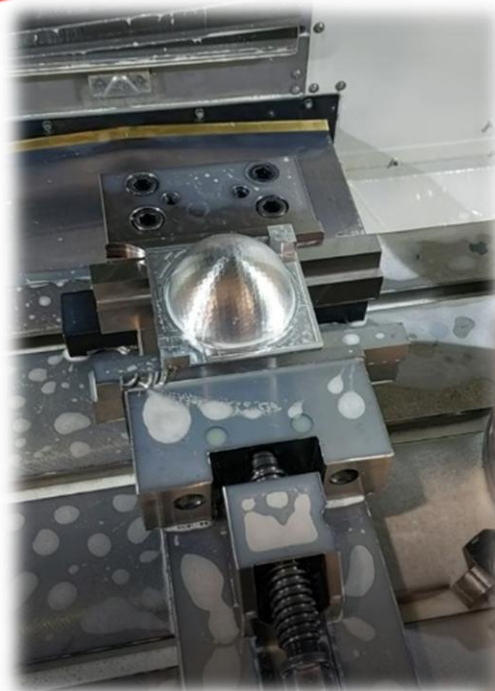

studen 2023.

Izrada stalaka za bor.



studeni 2023.

Zadruga je sudjelovala u obilježavanju aktivnosti Movember – mjesec muškog zdravlja. Tom prigodom izrađeni su privjesci na 3D printeru u obliku brkova. Aktivnosti su završene izborom najsimpatičnijeg brka škole.

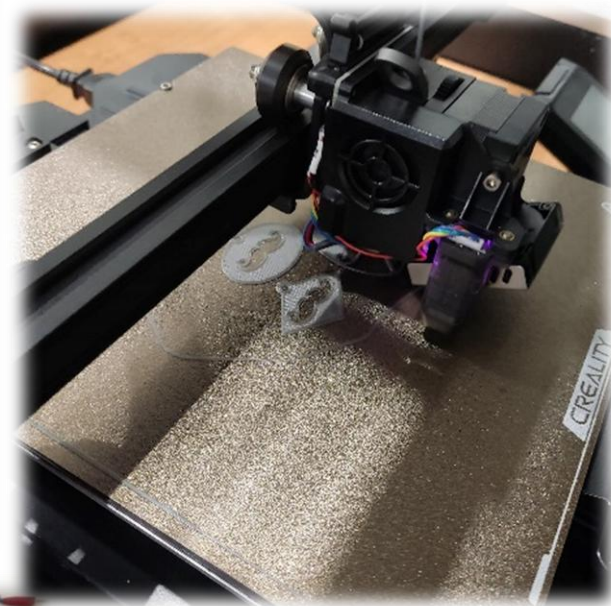

Izrađen je roštilj od inoksa u
školskoj radionici.

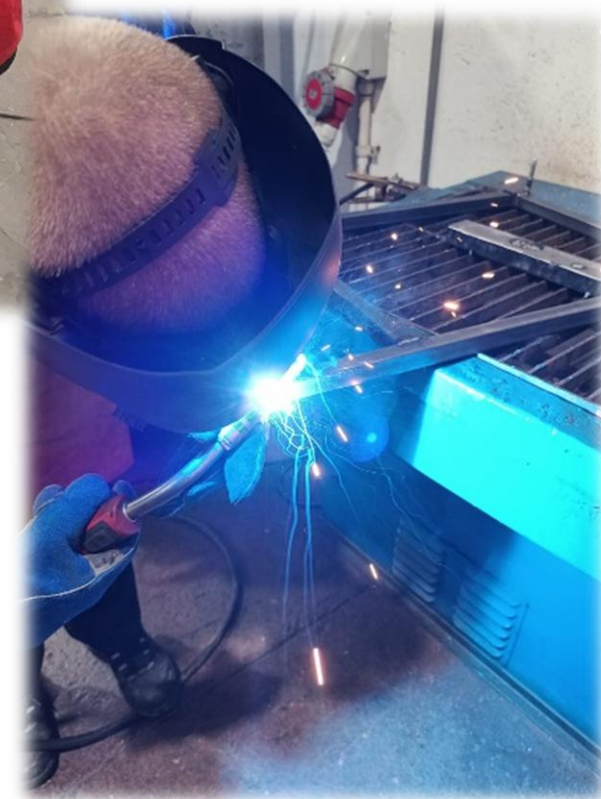

27. – 30. studenoga 2023.

Održane su radionice na kojima su članovi Zadruge izrađivali ukrase za božićno drveće koje je naknadno okićeno u holu škole.



6. prosinca 2023.

Proglašeni su najsimpatičniji brkovi škole nakon provedenog izbora na razini škole.



Povodom blagdana sv. Nikole održana je prodajna izložba – u ponudi su bile šibe s opomenama.



8. prosinca 2023.

Sekcija Kiss u suradnji s Martinom Mlađenović iz Kulturno-povijesnog centrom Sisačko-moslavačke županije održala je radionicu izrade preparativne kozmetike.



8. prosinca 2023.

U sklopu sekcije Eko svijet izrađena
je digitalna čestitka za Božić u
AutoCad-u.



15. prosinca 2023.

Održan je Božićni sajam u školi na kojem se predstavila Zadruga prodajnom izložbom.



prosinač 2023.

Započela je humanitarna akcija Ubaci čep za skupi lijek za članove Udruge oboljelih od leukemije i limfoma.



21. prosinca 2023.

Započeo projekt (re)KREATIVNI ZIOŠI u sklopu izvannastavnih aktivnosti srednjih škola pod pokroviteljstvom Ministarstva znanosti i obrazovanja.

Odluka o financiranju projekata u sklopu izvannastavnih aktivnosti osnovnih i srednjih škola te učeničkih domova u školskoj godini 2022./2023.
16.12.2022. | Stranica

Odluka o financiranju projekata u sklopu izvannastavnih aktivnosti osnovnih i srednjih škola te učeničkih domova u školskoj godini 2023./2024.
21.12.2023. | Pisane vijesti

Popis odobrenih projekata u sklopu izvannastavnih aktivnosti osnovnih i srednjih škola te učeničkih domova u školskoj godini 2023./2024.

Sredstva se raspoređuju na korisnike kako slijedi:

Aktivnost 579004:

13.	INDUSTRIJSKO-OBRTNIČKA ŠKOLA, Sisak	(re)KREATIVNI ZIOŠI	2.991,00
-----	-------------------------------------	---------------------	----------

13. i 27. veljače 2024.

Održane su edukativne radionice u
suradnji s Gradskim društvom Crvenog
križa Sisak:

- Prva pomoć
- Zaštita zdravlja



14. veljače 2024.

Prodajnom izložbom Zadruga je
obilježila Dan zaljubljenih.



22. veljače 2024.

Održan je sastanak i radionica Podružnice HSUZ-a Sisačko-moslavačke županije u OŠ Sela.

Održano je Međuzupanijsko stručno vijeće Zagrebačke i Sisačko-moslavačke županije za predmetno područje Učeničko poduzetništvo sa sljedećim temama i radionicama:

Teme i predavači:

1. Poduzetništvo je IN! (Anita Benčec Nikolovski),
2. Poduzetni za knjižnicu! (Iva Dužić i Željka Kleković Brajenović),
3. Poduzetništvo i Građanski odgoj i obrazovanje (Suzana Telar)

Radionice:

1. Izrada svijeća (Dubravka Kokan),
2. Platneni cvjetovi (Željka Kleković Brajenović).



4. ožujka 2024.

Započela je izrada Olimpijskog
vrta u školi.



ožujak 2024.

UZ ZIOŠI sudjelovala je u sadnji voćaka i cvijeća u školskom dvorištu.





8. ožujka 2024.

Zadruga je obilježila Dan žena. Svim učenicama i ženama djelatnicama škole poklonjeni su broševa u obliku cvijeta koje su izradili članovi Zadruge.





21. ožujka 2024.

Članovi Zadruga sudjelovali su u ekološkoj aktivnosti. U Vratečkom je zasađena paulovnja, drvo budućnosti.



27. ožujka 2024.

Održan je Proljetni sajam na kojemu se predstavila i UZ ZIOŠI.

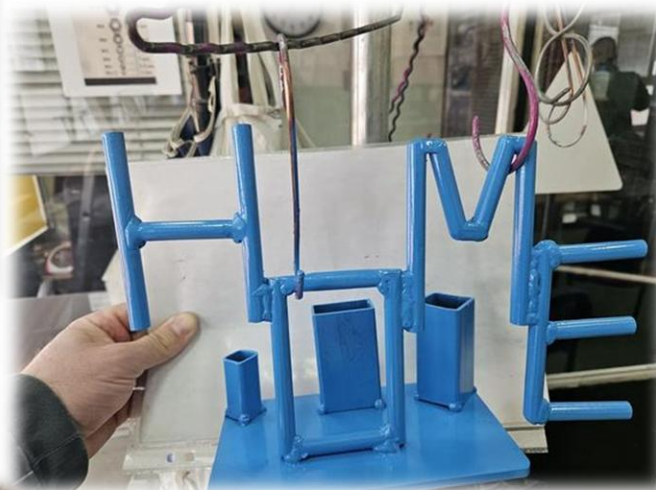

ožujak 2024.

Ekološka akcija - Minionsi
načinjeni od starih
automobilskih guma.





ožujak 2024.

Započela je humanitarna
aktivnost Osmijeh jedan
zdravlja vrijedan.



26. travnja 2024.

ZIOŠI su sudjelovali na Festivalu srednjih škola koji je održan u Ulici Stjepana i Antuna Radića u Sisku.



29. travnja 2024.

Svjetski dan plesa obilježio je
plesni klub Top step, a pomogli su i
Z(IOŠ)i.





9. svibnja 2024.

Zadruga je po prvi put sudjelovala na
Županijskoj smotri učeničkih zadruga –

Svjetlo baštine

u OŠ „Braća Bobetko”.



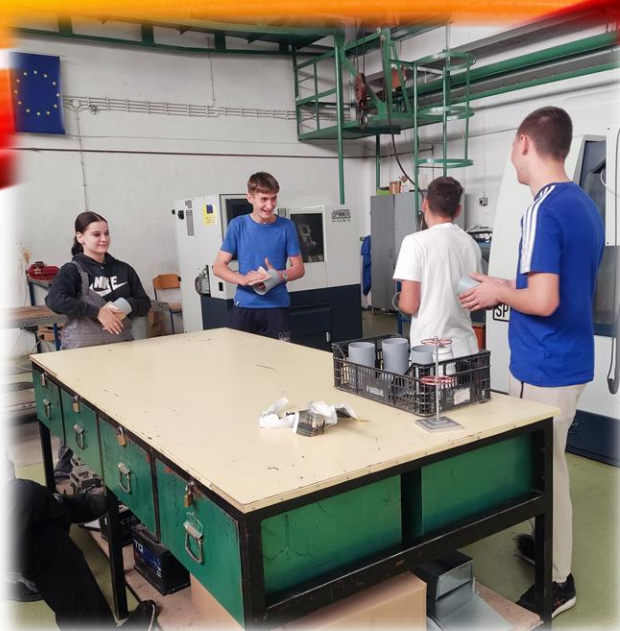

*90. obljetnica od izgradnje sisačkog Starog mosta
(1934./2024.)*





Učenička zadruga **ZIOŠI**

Učenička zadruga **ZIOŠI**

25. svibnja 2024.

Sudjelovanje na 18. Sajmu udruga i ustanova.



28. svibnja 2024.

Svečana sjednica povodom Dana škole na kojoj je predstavljen i rad UZ ZIOŠI.



Prodajna izložba učeničke zadruge ZIOŠI u NKČ Vlado Gotovac trajala je **od 31. svibnja do 15. lipnja 2024. godine.**

Prodajna izložba

"Svjetlo baštine"

Učenička zadruga ZIOŠI



31.5.2024. – 15.6.2024.

Narodna knjižnica i čitaonica Vlado Gotovac Sisak, Rimška 27

Autorice izložbe:

Marija Kosić i Ana Baiutti



Industrijsko-obrtnička škola Sisak



6. lipnja 2024.

Donacija igračaka Domu za djecu i odrasle žrtve nasilja u obitelji "Duga – Zagreb".



15. lipnja 2024.

Prodajna izložba na Prvenstvu RH u 10
sportskih plesova u organizaciji ŠPK

TOP STEP.



lipanj 2024.

Donacija 20 skulptura srca učenicima s teškoćama u razvoju koji su sudjelovali na Državnom natjecanju školskih sportskih društava.



lipanj 2024.

Predaja 950 starih baterija
(ukupno 16 kg) tvrtki Friš d.o.o.



srpanj 2024.

Pakiranje i slanje prikupljenih
plastičnih čepova Udruzi oboljelih
od leukemije i limfoma (UOLL),
Čakovec.

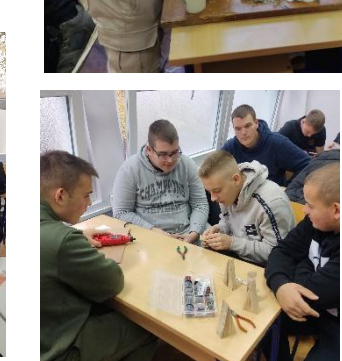
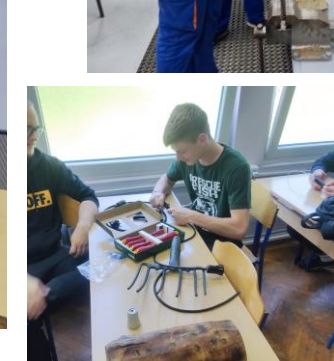
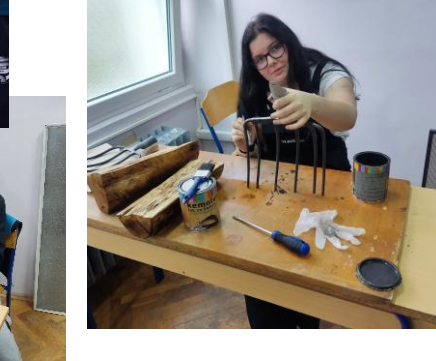
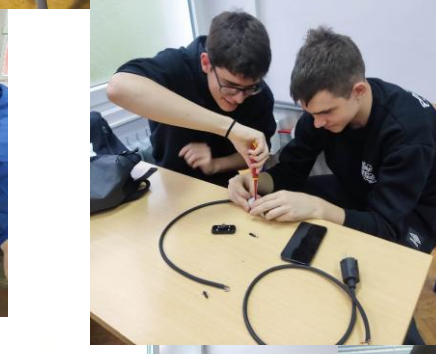
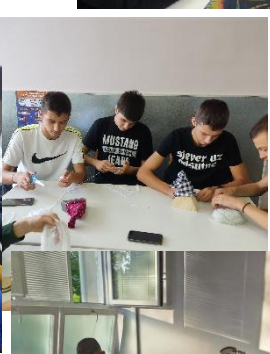
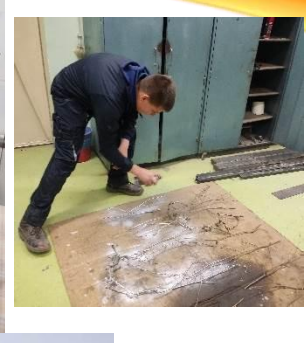
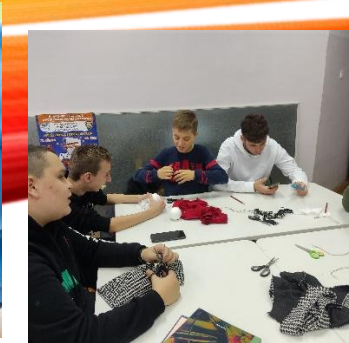

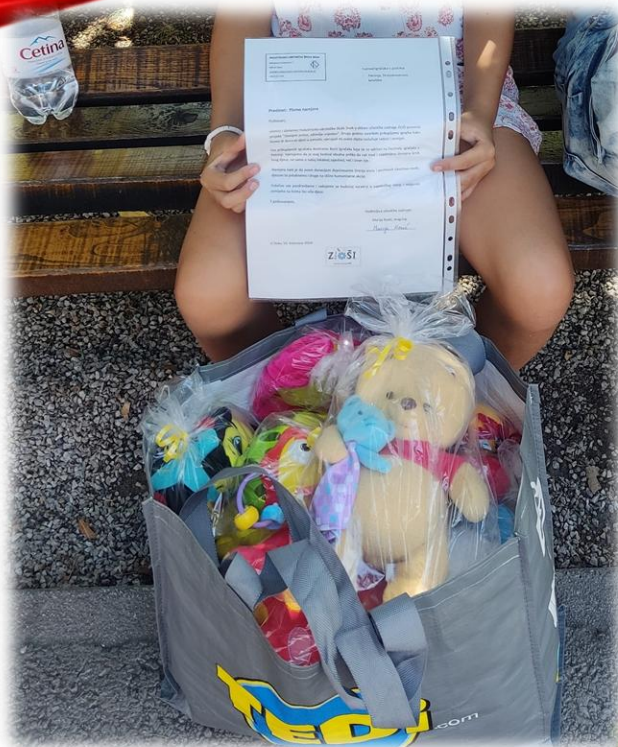

11. kolovoza 2024.

Dio igračaka prikupljenih u sklopu projekta "Osmijeh jedan, zdravlja vrijedan" donirali smo Burzi igračaka koja se nalazila na Festivalu igračaka u Petrinji.



13. kolovoza 2024.

Donacija igračaka, pernica, školskog pribora i boca za vodu prikupljenih u sklopu projekta "Osmijeh jedan, zdravlja vrijedan" školi u mjestu Paje na Zanzibaru.





Školska godina

2024. / 2025.

27. rujna 2024.

Industrijsko-obrtnička škola Sisak, Osnovna škola „Braća Bobetko” i Tehnička škola Sisak u okviru Europskog tjedna sporta organizirali su prvi školski kros 2024. Sudjelovalo je 184 učenika osnovne i srednjih škola.

ZIOŠI su dizajnirali i isprintali medalje na 3D printeru.

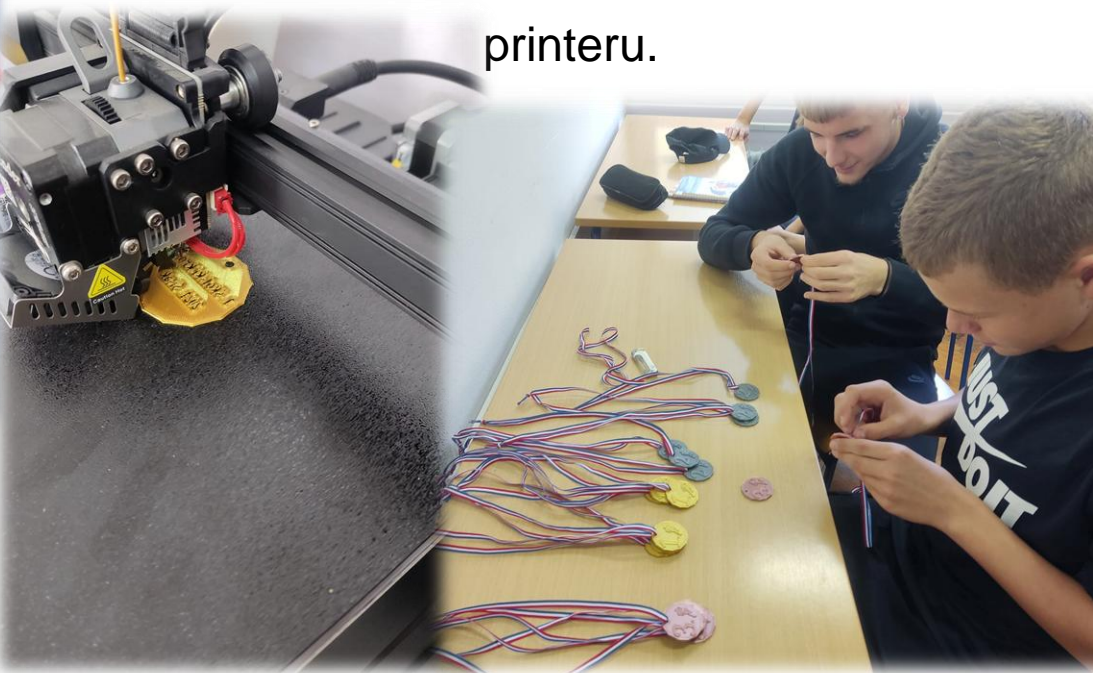

29. listopada 2024.

Pakiranje i donacija 70-ak plišanih igračaka
pedijatrijskoj ambulanti dr. Venera Zahariev
Španiček u Zaprešiću.



studeneni 2024.

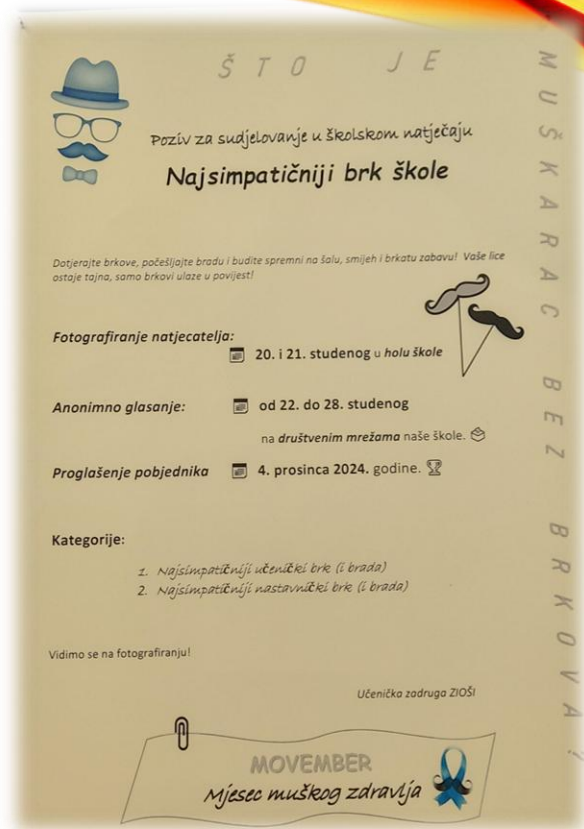

U sklopu Mjeseca muškog zdravlja i Dana muškaraca (19.11.) zadruga je drugu godinu za redom započela s aktivnostima za školski natječaj „Najsimpatičniji brk škole“.







Š T O J E

 Poziv za sudjelovanje u školskom natječaju
Najsimpatičniji brk škole

Dotjerajte brkove, počesljajte bradu i budite spremni na šalu, smijeh i brkату zabavu! Vaše lice ostaje tajna, samo brkovi ulaze u povijest!

Fotografiranje natjecatelja:  20. i 21. studenog u holi škole 

Anonimno glasanje:  od 22. do 28. studenog
na društvenim mrežama naše škole. 

Proglašenje pobjednika  4. prosinca 2024. godine. 

Kategorije:

1. Najsimpatičniji učenički brk (i brada)
2. Najsimpatičniji nastavnički brk (i brada)

Vidimo se na fotografiranju!

Učenička zadruga ZIOŠI

MOVEMBER
Mjesec muškog zdravlja 

M U Š K A R A C B E Z B R K O V A I





prosinač 2024. – Zahvala učenicima koji su se istaknuli u radu Učeničke zadruge.





10. siječnja 2025.

Obilježavanje Svjetskog dana smijeha
uz društvene igre.



siječanj 2025.

Virtualna izložba radova učeničkih zadruga
Sisačko-moslavačke županije.

  * UZ ZIOŠI, Industrijsko-obrtnička škola Sisak, Sisak

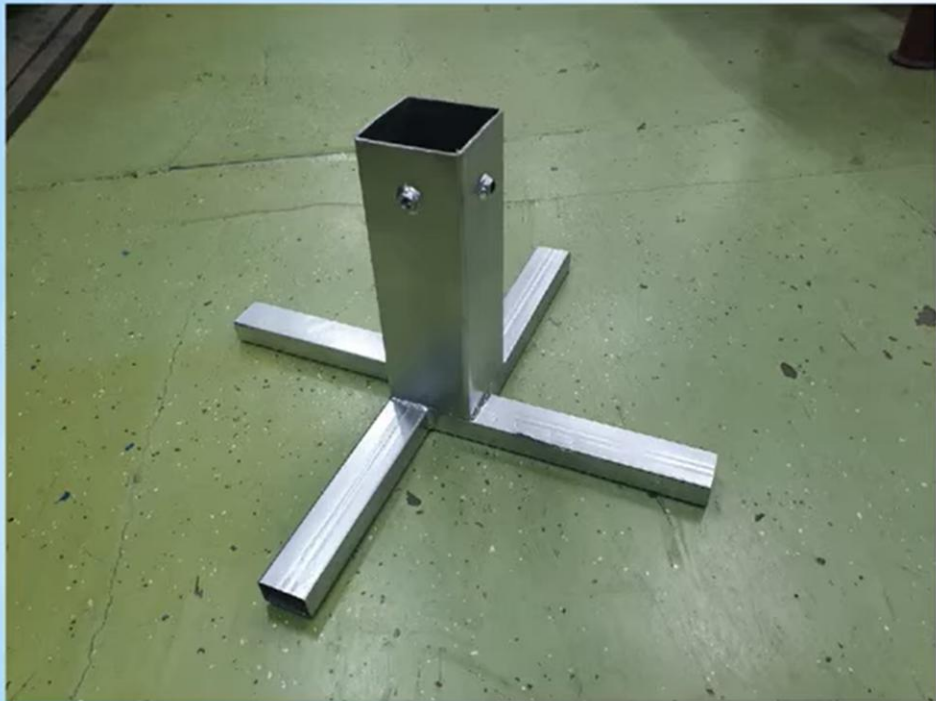

Učeničko Zadrugarstvo
24. siječnja · 🌐

IZLOŽBA RADOVA UČENIČKIH ZADRUGA ...

  Vi i 22 drugih 904 🗨️

 Super  Komentar  Podijeli

Komentari [Prikaži sve](#)

Prvi komentirajte.

7. veljače 2025.

Prodajna izložba učeničke
zadruge ZIOŠI na Danima
poslova Sisak u hotelu Panonija.



13. i 14. veljače 2025.

Aktivnosti ZIOŠa i prodajne izložbe
povodom Dana zaljubljenih.

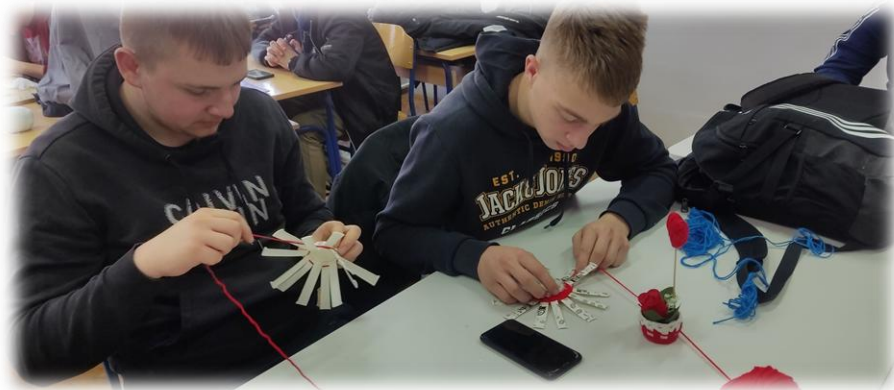

VALENTINOVO

Prodajna izložba

Datum: 13. i 14. veljače 2025.

Vrijeme: od 13:30 do 16:00 h

Mjesto: Industrijsko-obrtnička škola Sisak
Marijana Cvetkovića 2



*Pronađite jedinstvene učeničke radove i
darujte ih voljenoj osobi za savršeno
Valentino!*

Vidimo se!



26. veljače 2025.

Sastanak Podružnice HSUZ-a Sisačko-moslavačke županije i Međuzupanijsko stručno vijeće Zagrebačke i Sisačko-moslavačke županije za predmetno područje Učeničko poduzetništvo.



Predavanja:

- Organizacija Županijske smotre / Željka Kleković Brajenović, mag. prim. educ.
- Kriteriji vrednovanja na županijskim smotrama učeničkih zadruga / Željka Kleković Brajenović, mag. prim. educ.
- Izbor zastupnika Podružnice u Skupštinu HSUZ-a
- (re)KREATIVNI ZIOŠI - od ideje do realizacije - Marija Kosić, mag.ing.elektrotehnike

Radionice:

- Prikaz rada na CNC stroju - Stjepko Bašić, dipl. ing. Strojarstva
- Radionica izrade stolnih lampi od recikliranih materijala - Marija Kosić, mag.ing.elektrotehnike



7. ožujka 2025.

Radionice povodom Dana žena i prodajna izložba u holu škole.

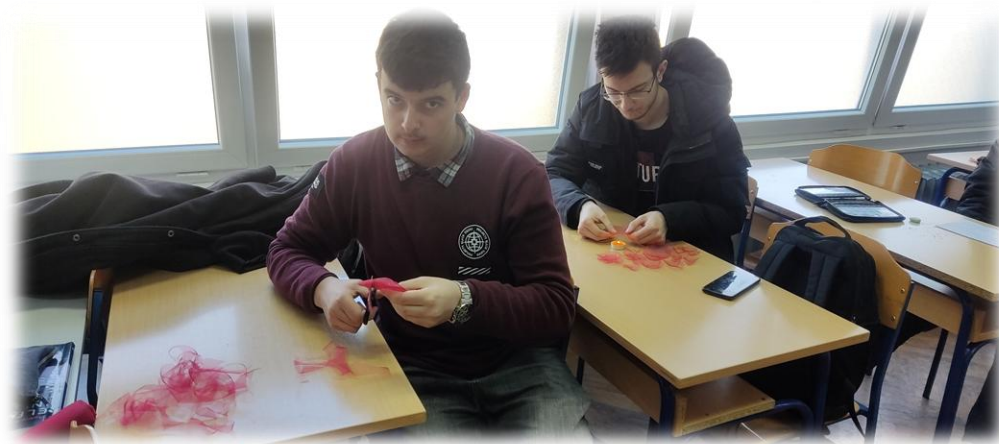

14. i 16. travnja 2025.

Uskrсни sajam – radionice i prodajne izložbe.



24. travnja 2025.

Predstavljanje rada učeničke zadruge ZIOŠI na Festivalu srednjih škola Sisačko-moslavačke županije.





Pretraži Facebook



Upravljajte stranicom



Učenička zadruga ZIOŠI



Nadzorna ploča za profesionalni račun



Analitika



Postavke

Centar za oglase

Create ads using a streamlined setup.



Kreiraj oglas



Boost Instagram content



Promovirajte sadržaj na Facebooku



Manage ads

Oglašavaj

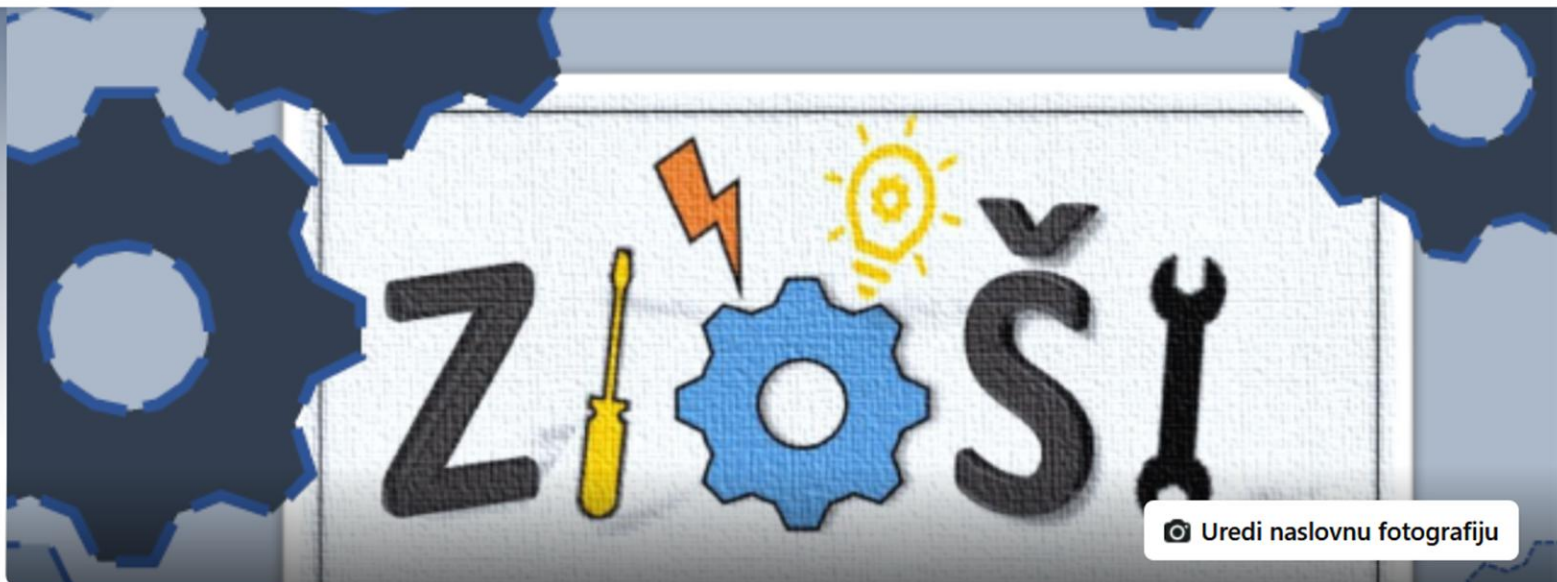

Uredi naslovnu fotografiju



Učenička zadruga ZIOŠI

44 oznake "sviđa mi se" • 185 pratitelji



Nadzorna ploča za profesionalni račun

Uredi

+ Dodajte priči

Objave

Informacije

Mentions

Osvrti

Reels

Fotografije

Više ▾





9. svibnja 2025.

Županijska smotra učeničkih zadruga u OŠ Gvozd.
Etno lampa s držačem ideja – spoj tradicije i modernih vještina!



17. svibnja 2025.

Sudjelovanje na 19. Sajmu udruga i ustanova, na kojem smo pronašli i fotografije naših volonterskih aktivnosti.



srpanj 2025.

Učenička zadruga ZIOŠI ponovno je sudjelovala u akciji prikupljanja starih baterija. Prikupljeno je 16 kilograma baterija koje će biti pravilno zbrinute.





Školska godina

2025. / 2026.

23. rujna 2025.

Povodom Europskog tjedna sporta Industrijsko-obrtnička škola Sisak i OŠ „Braća Bobetko“ organizirale su 2. školski kros. Medalje za najuspješnije izradila je UZ ZIOŠI.

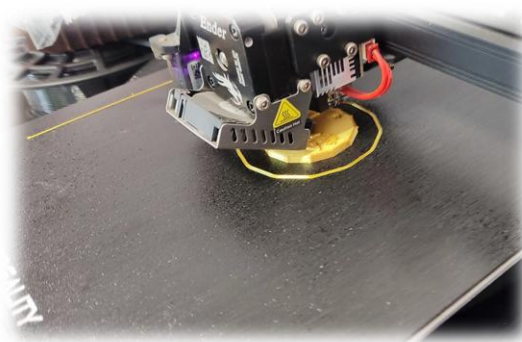

24. - 26. rujna 2025.

**37. smotra učeničkih zadruga
Republike Hrvatske, Poreč 2025.
- Etno lampa s držačem ideja -**



22. listopada 2025.

Sastanak i radionica Podružnice HSUZ-a
Sisačko-moslavačke županije:

1. Osvrt na 37. smotru učeničkih zadruga RH
2. Osvrt na Savjetovanje za voditelje Podružnica HSUZ-a
3. Izbori u Podružnici
4. Plan i program rada Podružnice u novoj školskoj godini
5. Razno

Radionica: Izrada keramičkog sviječnjaka – Željka
Kleković Brajenović, UZ VikSi, OŠ Viktorovac, Sisak



31. listopada 2025.

**Zadružna skupština
– nove ideje, novi članovi, nova energija!**



studen 2025.

Izrada brojeva za ključeve učionica.



13./ 14. studenoga 2025.

Održan je stručni skup za voditelje učeničkih zadruga i sekcija u učeničkim zadrugama u Termama Tuhelj.

Tema skupa bila je Razvoj poduzetničke ideje od koncepta do realizacije s dnevnim redom:



- Osnove projektnog planiranja , dr.sc. Verica Jovanovski, viša savjetnica za fiziku i učeničko poduzetništvo, Agencija za odgoj i obrazovanje
- Kako osmisлити dobru ideju i pretvoriti je u plan, Danijela Princi Grgat, dipl.oec., Hrvatski institut za financijsku edukaciju, Zagreb
- Kako napisati uvjerljiv i izvediv poslovni plan, Ana Vrbošić, dipl.oec., Hrvatski institut za financijsku edukaciju, Zagreb
- Kad ideja postane projekt – priča zadruga Turnić i TehničaRI, Dijana Malinić Mihelić, mag.educ., Tehnička škola Rijeka, Josipa Andrušić, prof., Osnovna škola Turnić
- Poduzetništvo u učeničkoj zadruzi kao Erasmus+ akreditacija, Anastazija Komljenović, prof., Osnovna škola Slavka Kolara, Kravarsko
- Projektna ideja koja dobiva zeleno svjetlo, Patricija Burazin, dipl.učitelj, Osnovna škola Blage Zadre, Vukovar
- Leptiri u umjetnosti i znanosti, Amalija Misir-Čujko, dipl.ing., Osnovna škola Barilović, Barilović
- Poduzetništvo srcem: školski projekti Katoličke osnovne škole Šibenik, Antonija Mamužić, dipl.učitelj, Katolička osnovna škola, Šibenik
- Projekt UZ Mrav: Malim koracima prema održivoj školi, Tamara Brozović Jurišić, prof., IV.osnovna škola, Bjelovar
- Spora moda – ekološki izazovi i istraživački pristup u radu učeničke zadruge, Kristina Veselovac, prof. i Kornelija Sabolek, mag.ing., Srednja škola Donji Miholjac
- Od STEM-a do poduzetništva: kako projekti jačaju rad učeničke zadruge, Melita Brodar, prof, Osnovna škola Ivana Kukuljevića Sakcinskog, Ivanec



studenii 2024.

Aktivnosti u sklopu Mjeseca muškog zdravlja i Dana muškaraca (19.11.): prodajna izložba, podjela edukativnih infografika o muškom zdravlju, izbor „Najsimpatičnijeg brka škole“.



27. studenoga 2025.

Međužupanijsko stručno vijeće Zagrebačke i Sisačko-moslavačke županije za predmetno područje Učeničko poduzetništvo:

1. Plan i program rada ŽSV u školskoj godini 2025./2026., Željka Kleković Brajenović, mag. prim. educ.
2. Razvoj poduzetničke ideje od koncepta do realizacije i poduzetništvo u cjelodnevnoj školi- Izvješće s Državnog stručnog skupa, Marija Kosić, mag.ing.elektrotehnike
3. Od ideje do akcije, Patricija Burazin, dipl. učitelj u zvanju izvrsnog savjetnika
4. Očuvajmo slamu- radionica, Katarina Dobrenić, učitelj razredne nastave s pojačanim programom iz hrvatskog jezika
5. Pletemo prstima – radionica, Željka Kleković Brajenović, mag. prim. educ.



prosinac 2025.

Izrada i donacija gipsanih skulptura ruku za sudionike uključene u projekt „6 škola jedan cilj – zajedno jači od ovisnosti“, koji provode Sisačko-moslavačka županija i Policijska uprava sisačko-moslavačka.

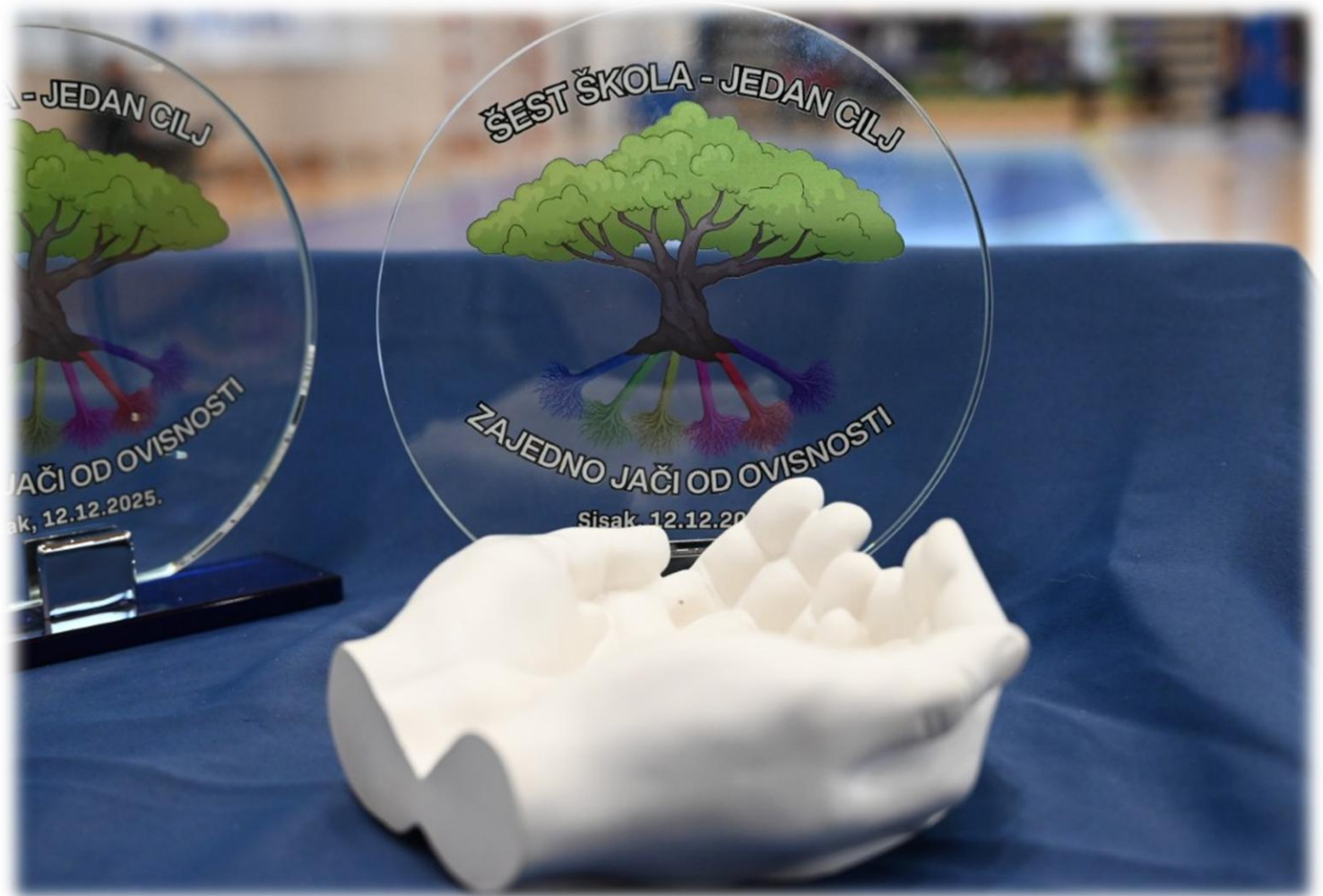

10. i 18. prosinca 2025.

Suradnja OŠ "Braća Bobetko" i
Industrijsko-obrtničke škole Sisak.



Od škole do škole ... u božićnom transferu ideja i kreativnosti. Pogledajte unikatne rukotvorine naših učenika. Izaberite nešto za sebe i svoje najmilije!

Učeničke zadruge Leptirići i ZIOŠI pozivaju Vas na:

Božićni sajam

1. STANICA:
10. prosinca 2025.
od 9:00 do 10:00 h
Osnovna škola "Braća Bobetko"
Marijana Cvetkovića 24

2. STANICA:
18. prosinca 2025.
od 13:00 do 16:00 h
Industrijsko-obrtnička škola Sisak
Marijana Cvetkovića 2

Suradnja između OŠ „Braća Bobetko“ i Industrijsko-obrtničke škole Sisak

18. prosinca 2025.

Humanitarna božićna prodaja u Industrijsko-
obrtničkoj školi Sisak.

Proglašenje „Najsimpatičnijeg brka škole”.



30. prosinca 2025.

Odluka o financiranju projekata u sklopu izvannastavnih aktivnosti osnovnih i srednjih škola te učeničkih domova u školskoj godini 2025./2026.

30.12.2025. | Pisane vijesti | Odluke | Odgoj i obrazovanje

Započinje projekt *(re)KREATIVNI ZIOŠI 2.0 – U Teslinim tragovima* u sklopu izvannastavnih aktivnosti srednjih škola pod pokroviteljstvom Ministarstva znanosti, obrazovanja i mladih.

Popis odobrenih projekata u sklopu izvannastavnih aktivnosti osnovnih i srednjih škola te učeničkih domova u školskoj godini 2025./2026.

Sredstva se raspoređuju na korisnike kako slijedi:

Aktivnost 579004:

13.	INDUSTRIJSKO-OBRTNIČKA ŠKOLA, Sisak	(Re)kreativni ZIOŠI 2.0. - U Teslinim tragovima	4.000,00
-----	-------------------------------------	---	----------

23. siječnja 2026.

Izrada poklona za Stručno vijeće knjižničara i
predstavljanje rada UZ ZIOŠI.



11. i 13. veljače 2026.

Valentinovo – prodajne
izložbe



VALENTINOVO

Prodajna izložba

Datum: 11. i 13. veljače 2026.

Vrijeme: od 13:00 do 16:00 h

Mjesto: Industrijsko-obrtnička škola Sisak
Marijana Cvetkovića 2



*Odaberite jedinstvene učeničke radove i
poklonite ljubav u malom, posebnom
obliku!*

Vidimo se!



27. veljače 2026.

Na dodjeli Volonterskih nagrada Grada Siska Industrijsko-obrtnička škola Sisak osvojila je 3. mjesto u kategoriji Razvoj volonterstva u obrazovanju. Posebno smo ponosni što su se volonterske aktivnosti provodile kroz učeničku zadrugu.



Rastemo zajedno 2025

Dodjela
volonterskih
nagrada
Grada Siska

27.2.2026. u 17:00h
NKČ Vlado Gotovac Sisak



IZLOŽBA FOTOGRAFIJA VOLONTERSKIH PROGRAMA
S PODRUČJA SISAČKO-MOSLAVAČKE ŽUPANIJE



Partneri projekata: OŠ Ivana Antelčića Komarevo, Srednja škola Glina, Grad Sisak i Grad Glina.

Izložbu sponzoriraju Ministarstvo rada, mirovinskoga sustava, obitelji i socijalne politike i Grad Sisak. Snajplika izražava u ovoj publikaciji isključivo su odgovornost Agencije lokalne demokratije Sisak i ne održavaju nižno stajalište Ministarstva i Grada Siska.



3. ožujka 2026.

Učenici učeničke zadruge ZIOŠI pripremili su prigodne poklone za Vijeće pedagoga koje je održano u našoj školi.

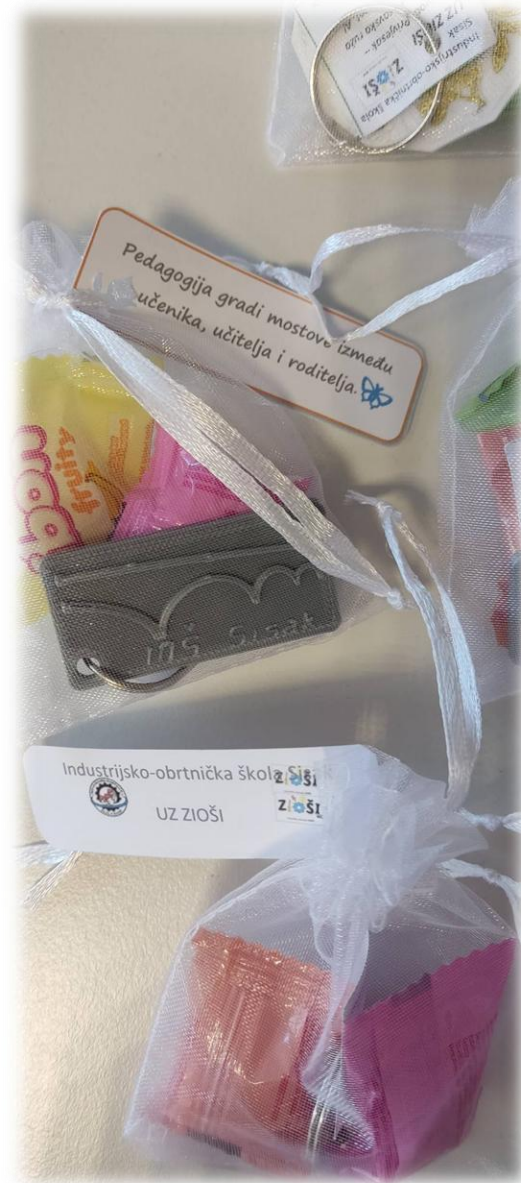

6. ožujka 2026.

Dan žena – podjela simboličnih poklona učenicima
i djelatnicama IOŠ Sisak i prodajna izložba.



19. ožujka 2026.

Prodajna izložba za Dan očeva.



19. ožujka 2026.

Sastanak i radionica Podružnice HSUZ-a Sisačko-moslavačke županije u OŠ 22. lipnja:

1. Županijska smotra učeničkih zadruga SMŽ
2. Posebna pravila natjecanja/smotra učeničkih zadruga RH u šk. godini 2025./2026.
3. Razno

ŽSV za učeničko poduzetništvo:

1. Posebna pravila natjecanja/smotra učeničkih zadruga RH u školskoj godini 2025./2026., Željka Kleković Brajenović, mag. prim. educ.
2. Estetika i funkcionalnost u oblikovanju izložbenog prostora učeničke zadruge, Željka Kleković Brajenović, mag. prim. educ.
3. Proizvodnja sapuna na tradicionalan način, Greta Sremić-Cavrić, dipl.ing.preh.teh

Radionica: Izrada sapuna- Greta Sremić-Cavrić, dipl.ing.preh.teh

Radionica: Od gotovog proizvoda do tržišta – ambalaža, deklaracija i plasman, Željka Kleković Brajenović, mag. prim. educ.



27. ožujka 2026.

Prodajna izložba ususret Uskrsu.





8. travnja 2026.

Učenci UZ ZIOŠI sudjelovali su u sadnji cvijeća u žardinjere ispred škole u sklopu projekta „Škole za ekološku pravednost”.

14. travnja 2026.

Predstavljanje zadruga i prodajna izložba na
Danima otvorenih vrata naše škole.



16. travnja 2026.

Izrada povišenih gredica od starih guma i sadnja cvijeća, uključujući lavandu, ružmarin, kamilicu i čuvarkuću, u sklopu projekta „Škole za ekološku pravednost”.



22. travnja 2026.

2. Zoom predavanja u organizaciji HSUZ-a: primjeri i praksa

Multisenzorni detalji

- ugodna rasvjeta (topla svjetla umjesto hladnih neonki)
- blagi prirodni mirisi (ako je prikladno)
- različite teksture (drvo, tkanina, keramika)



Estetski izgled izložbenog prostora

Snježana Hranić, mag. prim. educ.,
izvršni savjetnik

1. Estetsko uređenje štanda / Snježana Hranić, mag. prim. educ. / OŠ Sveti Đurđ, Sveti Đurđ / UZ Jurek
2. Poduzetničke aktivnosti Učeničke zadruge Trišnja ka održivosti - iskustva i primjeri dobre prakse / Mara Midžor, dipl. ing. agronomije / SŠ Braća Radić, Kaštel Štafilić /UZ Trišnja
3. Preko trnja do zvijezda / Ljiljana Kadija Pulić uč. inf. / OŠ Sveti Filip i Jakov, Sveti Filip i Jakov / UZ Đardin
4. Tehnologija u službi prirode: pametni vrtovi i hidroponski uzgoj biljaka / Tajana Kovačević, prof. biologije i kemije / OŠ Sibirskih žrtava, Sibinj i Ana Holik, uč. raz. nas. / PRO Grgurevići, Sibinj / UZ Zlatno klasje

23. travnja 2026.

Festival srednjih škola Sisačko-moslavačke
županije – prodajna izložba i predstavljanje rada
učeničke zadruge.



24. travnja 2026.

Izlet u Smiljan povodom obilježavanja 170.

obljetnice Teslina rođenja.

- aktivnost u sklopu projekta (re)kreativni ZIOŠI
2.0 – U Teslinim tragovima



ZAKLJUČCI

Motivacija Poduzetnost

Natječaji Opuštanje

Projekti

Kreativnost

Samopouzdanje

Izvješća

Suradnja

Povezivanje

Slobodno vrijeme

Druženje

Ideje

Uvijek je
lakše

kad imate
nekoga



tko vas motivira

Timski rad

Zadovoljstvo



USPJEH JE
ZBIRKA
RIJEŠENIH
PROBLEMA

I.M.PEI